



# ZERO SHAPES

Enzo Panzeri 2022

Registered Design



Lampada a sospensione orizzontale in alluminio estruso curvato, con schermo in policarbonato opale. Emissione interna attraverso modulo LED e tecnologia ZigBee di serie su tutte le versioni inserita nel rosone. Anello rifinito con vernice poliacrilica color bianco, nero, titanio, bronzo e ottone satinato. Ideale per ambienti residenziali e zone living.

Horizontal suspension lamp in extruded curved aluminum, with opal polycarbonate screen. Emission on the internal side provided by LED modules with ZigBee technology integrated into the canopy. Polyacrilic paint white, black, titanium, bronze and mat brass finishes are available. Ideal for residential spaces and living areas.

NOVELTY	CODICE CODE	FONTI LUMINOSE LIGHT SOURCES	kg
---------	-------------	------------------------------	----

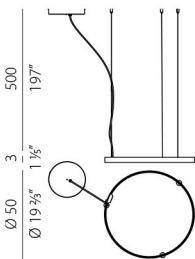

-  **L03301.050.0523**
- L03302.050.0523**
- L03317.050.0523**
- L03319.050.0523**
- L03330.050.0523**

Potenza assorbita apparecchio / Luminaire power consumption 25W  
 Flusso luminoso apparecchio / Luminaire luminous flux 2039lm  
 2700K Ra>90 220-240V AC dimmable (ZigBee)

 IP20

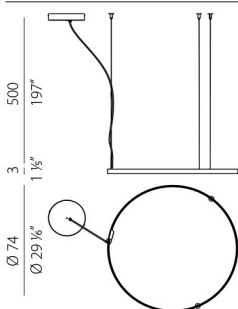

-  **L03301.075.0523**
- L03302.075.0523**
- L03317.075.0523**
- L03319.075.0523**
- L03330.075.0523**

Potenza assorbita apparecchio / Luminaire power consumption 36W  
 Flusso luminoso apparecchio / Luminaire luminous flux 3059lm  
 2700K Ra>90 220-240V AC dimmable (ZigBee)

 IP20

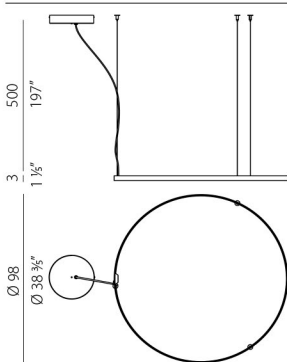

-  **L03301.100.0523**
- L03302.100.0523**
- L03317.100.0523**
- L03319.100.0523**
- L03330.100.0523**

Potenza assorbita apparecchio / Luminaire power consumption 47W  
 Flusso luminoso apparecchio / Luminaire luminous flux 4079lm  
 2700K Ra>90 220-240V AC dimmable (ZigBee)

 IP20



### YCO.T001

Telecomando per dispositivi wireless ZigBee, per accensione/spengimento e regolazione di 4 gruppi di massimo 30 corpi illuminanti.

Remote controller for ZigBee wireless devices, supporting switch and dimming control of 4 groups with up to 30 lighting fixtures maximum.

Fotometrie disponibili [www.panzeri.it](http://www.panzeri.it) / Photometric data available at [www.panzeri.it](http://www.panzeri.it)

### CODICI COLORI DISPONIBILI / COLOUR CODES AVAILABLE

- |                           |                         |                            |  |                               |
|---------------------------|-------------------------|----------------------------|--|-------------------------------|
| <b>01</b> bianco<br>white | <b>02</b> nero<br>black | <b>17</b> bronzo<br>bronze | <b>19</b> ottone satinato<br>mat brass | <b>30</b> titanio<br>titanium |
|---------------------------|-------------------------|----------------------------|--|-------------------------------|

## ZERO ROUND SMART

Zero Round Smart è collegabile facilmente alle reti domestiche esistenti e non richiede modifiche all'impianto elettrico.

Accensione, spegnimento e regolazione della luce possono avvenire in diversi modi, tramite telecomando, smartphone, assistente vocale, ...

Di seguito alcuni esempi di configurazioni possibili.

Zero Round Smart could be easily connected to existing home networks and does not require modification to electrical system.

Switching on, switching off and dimming of the light could be obtained in various ways, through remote control, smartphone, voice assistant...

As follow some examples of possible configurations.

### Esempio 01/ Example 01



L'apparecchio d'illuminazione può essere controllato grazie al telecomando (accessorio). **Non richiede una connessione internet o modifiche all'impianto elettrico.**

Lighting fixtures could be controlled by remote control (accessory). **It does not require an internet connection or modifications to the electrical system.**

## ZERO ROUND SMART

### Esempio 02 / Example 02



L'apparecchio d'illuminazione può essere controllato tramite assistente vocale e altri dispositivi di controllo smart, come smartphone, ecc. Necessita di una connessione internet e di un hub ZigBee\* (ad esempio Philips Hue Bridge v.2.0\*, raccomandato). Possibilità di controllo anche tramite telecomando. **Non sono necessarie modifiche all'impianto elettrico.**

Lighting fixtures could be controlled by voice assistant and other smart control devices, such as smartphones, etc. Internet connection and ZigBee\* hub required (e.g. Philips Hue Bridge v.2.0\*, recommended). Possibility of control also by remote control. **Modifications to the electrical system not required.**

### Esempio 03 / Example 03

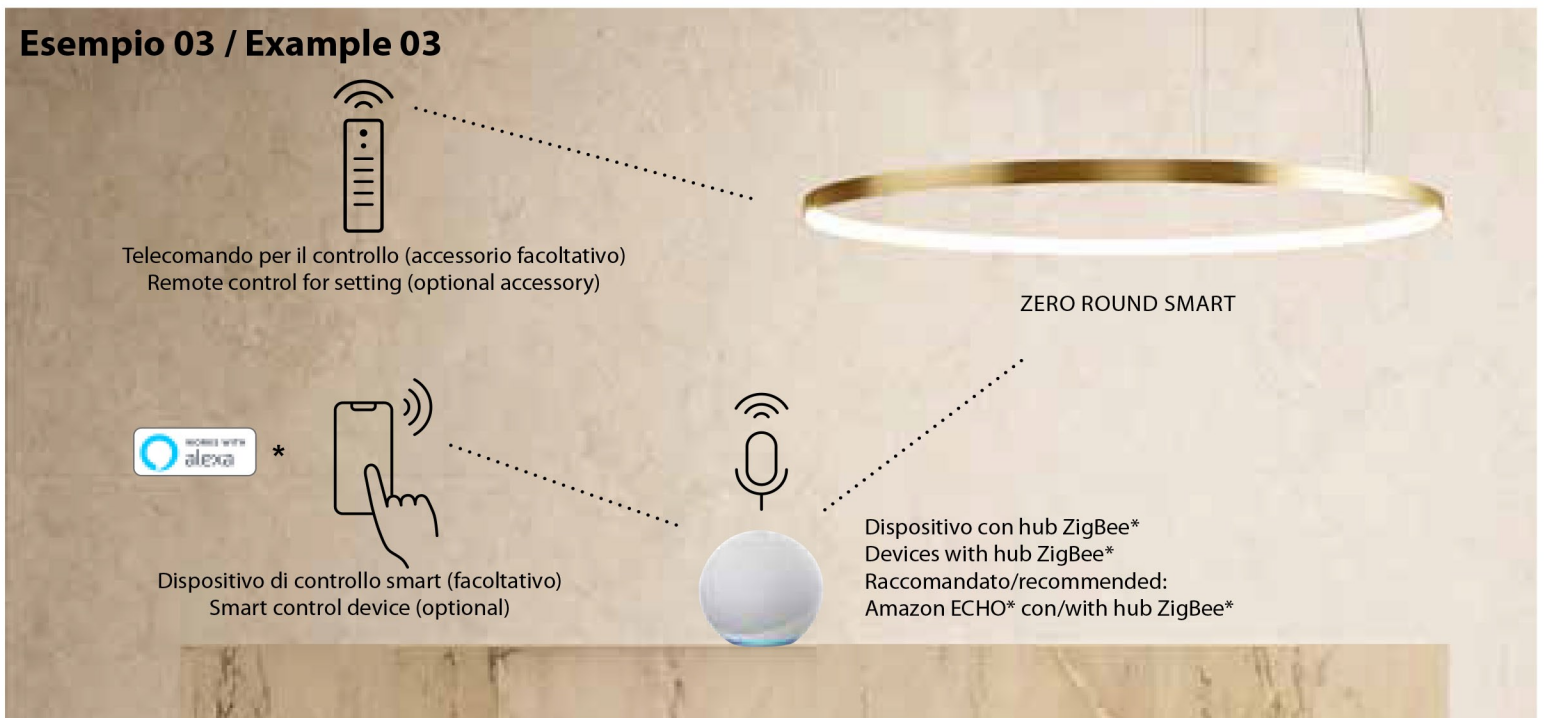

L'apparecchio d'illuminazione può essere controllato tramite assistente vocale e dispositivi di controllo smart, come smartphone, ecc. Necessita di una connessione internet Wi-Fi e di un assistente vocale con hub ZigBee\* integrato (Amazon Echo\* con hub ZigBee\* raccomandato). Possibilità di controllo anche tramite telecomando. **Non sono necessarie modifiche all'impianto elettrico.**

Lighting fixtures could be controlled by voice assistant and smart control devices, such as smartphones, etc. Wi-Fi internet connection and voice assistant with integrated ZigBee\* hub required (Amazon Echo\* with hub ZigBee\* recommended). Possibility of control also by remote control. **Modifications to the electrical system not required.**

\*ZigBee, Philips Hue Bridge, Amazon Echo, Alexa, Hey Google e Apple HomeKit sono marchi registrati di terzi senza alcun collegamento con Panzeri Carlo s.r.l.

\*ZigBee, Philips Hue Bridge, Amazon Echo, Alexa, Hey Google e Apple HomeKit are registered trademarks without any relationship with Panzeri Carlo s.r.l.





# ZERO SHAPES

Enzo Panzeri 2018

Registered Design

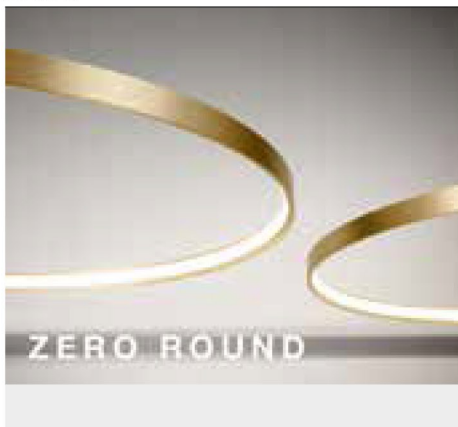

Lampada a sospensione orizzontale, a parete e a soffitto in alluminio estruso curvato, con schermo in policarbonato opale. Emissione interna attraverso modulo LED e tecnologia DALI/Push DIM di serie su tutte le versioni inserita nel rosone. Anello rifinito con vernice poliaccrilica color bianco, nero, titanio, bronzo e ottone satinato. Disponibilità di rosone per installazioni singole e per composizioni multiple da ordinare separatamente. Ideale per uffici, hall, zone living, grandi spazi, anche in abbinamento con Zero Round Acoustic e Arena Acoustic.

Horizontal suspension lamp, wall and ceiling lamp in extruded curved aluminum, with opal polycarbonate screen. Emission on the internal side provided by LED modules with technology DALI/Push DIM integrated into the canopy. Polyacrylic paint white, black, titanium, bronze and mat brass finishes are available. Canopies for single and multiple configurations with Zero Ellipse and Zero Square are available, to be ordered separately. Ideal for offices, halls, living, and public spaces, also combined with Zero Round Acoustic and Arena Acoustic.

## NOVELTY

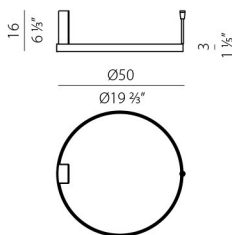

**CODICE CODE**  
**P03301.050.0502**  
**P03302.050.0502**  
**P03317.050.0502**  
**P03319.050.0502**  
**P03330.050.0502**

**FONTI LUMINOSE LIGHT SOURCES**  
 Potenza assorbita apparecchio / Luminaire power consumption 29W  
 Flusso luminoso apparecchio / Luminaire luminous flux 2039lm  
 2700K Ra>90 220-240V AC dimmable (DALI/Push DIM)

IP20

kg

1,41



**P03301.050.0402**  
**P03302.050.0402**  
**P03317.050.0402**  
**P03319.050.0402**  
**P03330.050.0402**

Potenza assorbita apparecchio / Luminaire power consumption 29W  
 Flusso luminoso apparecchio / Luminaire luminous flux 2039lm  
 3000K Ra>90 220-240V AC dimmable (DALI/Push DIM)

IP20

1,41

## NOVELTY

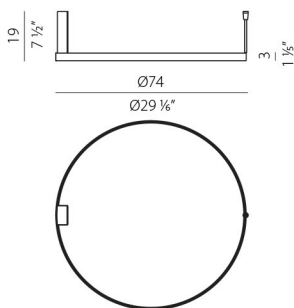

**P03301.075.0502**  
**P03302.075.0502**  
**P03317.075.0502**  
**P03319.075.0502**  
**P03330.075.0502**

Potenza assorbita apparecchio / Luminaire power consumption 42W  
 Flusso luminoso apparecchio / Luminaire luminous flux 3059lm  
 2700K Ra>90 220-240V AC dimmable (DALI/Push DIM)

IP20

1,80



**P03301.075.0402**  
**P03302.075.0402**  
**P03317.075.0402**  
**P03319.075.0402**  
**P03330.075.0402**

Potenza assorbita apparecchio / Luminaire power consumption 42W  
 Flusso luminoso apparecchio / Luminaire luminous flux 3059lm  
 3000K Ra>90 220-240V AC dimmable (DALI/Push DIM)

IP20

1,80

## NOVELTY

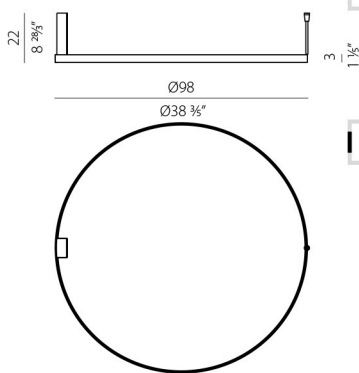

**P03301.100.0502**  
**P03302.100.0502**  
**P03317.100.0502**  
**P03319.100.0502**  
**P03330.100.0502**

Potenza assorbita apparecchio / Luminaire power consumption 54W  
 Flusso luminoso apparecchio / Luminaire luminous flux 4079lm  
 2700K Ra>90 220-240V AC dimmable (DALI/Push DIM)

IP20

2,06



**P03301.100.0402**  
**P03302.100.0402**  
**P03317.100.0402**  
**P03319.100.0402**  
**P03330.100.0402**

Potenza assorbita apparecchio / Luminaire power consumption 54W  
 Flusso luminoso apparecchio / Luminaire luminous flux 4079lm  
 3000K Ra>90 220-240V AC dimmable (DALI/Push DIM)

IP20

2,06

# ZERO SHAPES

Enzo Panzeri 2018

Registered Design

CODICE  
CODE

FONTI LUMINOSE  
LIGHT SOURCES

kg

## NOVELTY

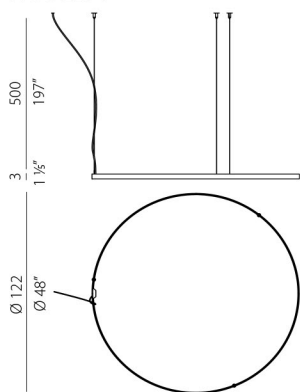

**M10301.125.0510**  
**M10302.125.0510**  
**M10317.125.0510**  
**M10319.125.0510**  
**M10330.125.0510**

Potenza assorbita apparecchio / Luminaire power consumption 62W  
Flusso luminoso apparecchio / Luminaire luminous flux 5099lm  
2700K Ra>90 24V DC  
 **IP20**   
Fornito senza rosone e driver, per composizioni singole o multiple  
Supplied without canopy and driver, for multiple configurations



**M10301.125.0410**  
**M10302.125.0410**  
**M10317.125.0410**  
**M10319.125.0410**  
**M10330.125.0410**

Potenza assorbita apparecchio / Luminaire power consumption 62W  
Flusso luminoso apparecchio / Luminaire luminous flux 5099lm  
3000K Ra>90 24V DC  
 **IP20**   
Fornito senza rosone e driver, per composizioni singole o multiple  
Supplied without canopy and driver, for multiple configurations

## NOVELTY

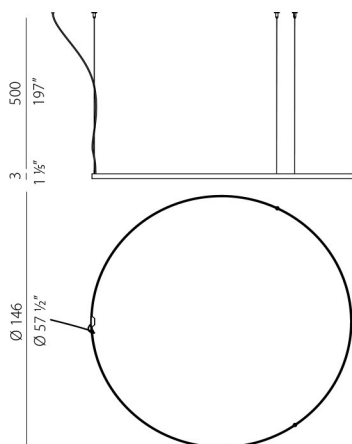

**M10301.150.0510**  
**M10302.150.0510**  
**M10317.150.0510**  
**M10319.150.0510**  
**M10330.150.0510**

Potenza assorbita apparecchio / Luminaire power consumption 71W  
Flusso luminoso apparecchio / Luminaire luminous flux 6120lm  
2700K Ra>90 24V DC  
 **IP20**   
Fornito senza rosone e driver, per composizioni singole o multiple  
Supplied without canopy and driver, for multiple configurations



**M10301.150.0410**  
**M10302.150.0410**  
**M10317.150.0410**  
**M10319.150.0410**  
**M10330.150.0410**

Potenza assorbita apparecchio / Luminaire power consumption 71W  
Flusso luminoso apparecchio / Luminaire luminous flux 6120lm  
3000K Ra>90 24V DC  
 **IP20**   
Fornito senza rosone e driver, per composizioni singole o multiple  
Supplied without canopy and driver, for multiple configurations

## NOVELTY

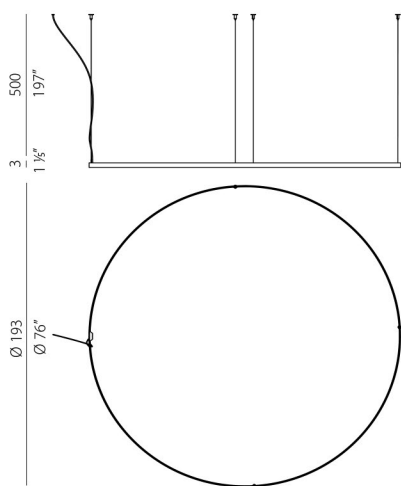

**M10301.200.0510**  
**M10302.200.0510**  
**M10317.200.0510**  
**M10319.200.0510**  
**M10330.200.0510**

Potenza assorbita apparecchio / Luminaire power consumption 88W  
Flusso luminoso apparecchio / Luminaire luminous flux 8158lm  
2700K Ra>90 24V DC  
 **IP20**   
Fornito senza rosone e driver, per composizioni singole o multiple  
Supplied without canopy and driver, for multiple configurations



**M10301.200.0410**  
**M10302.200.0410**  
**M10317.200.0410**  
**M10319.200.0410**  
**M10330.200.0410**

Potenza assorbita apparecchio / Luminaire power consumption 88W  
Flusso luminoso apparecchio / Luminaire luminous flux 8158lm  
3000K Ra>90 24V DC  
 **IP20**   
Fornito senza rosone e driver, per composizioni singole o multiple  
Supplied without canopy and driver, for multiple configurations

## NOVELTY

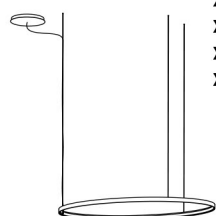
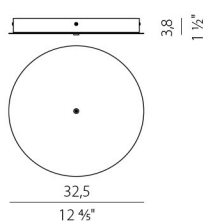

**XM10301.521.0002**  
**XM10302.521.0002**  
**XM10317.521.0002**  
**XM10319.521.0002**  
**XM10330.521.0002**

Rosone per alimentazione di 1 modello Zero Round 125 - Zero Round 150 - Zero Round 200, con driver DALI/Push DIM.  
Canopy for power supply of 1 Zero Round 125 - Zero Round 150 - Zero Round 200 model, with DALI/Push DIM driver.

# ZERO SHAPES

Enzo Panzeri 2018

Registered Design

	CODICE CODE	FONTE LUMINOSE LIGHT SOURCES	kg
	<b>M03301.050.0510</b> <b>M03302.050.0510</b> <b>M03317.050.0510</b> <b>M03319.050.0510</b> <b>M03330.050.0510</b>	Potenza assorbita apparecchio / Luminaire power consumption 25W Flusso luminoso apparecchio / Luminaire luminous flux 2039lm 2700K Ra>90 24V DC LED IP20	0,83
	<b>M03301.050.0410</b> <b>M03302.050.0410</b> <b>M03317.050.0410</b> <b>M03319.050.0410</b> <b>M03330.050.0410</b>	Potenza assorbita apparecchio / Luminaire power consumption 25W Flusso luminoso apparecchio / Luminaire luminous flux 2039lm 3000K Ra>90 24V DC LED IP20	0,83
	<b>M03301.075.0510</b> <b>M03302.075.0510</b> <b>M03317.075.0510</b> <b>M03319.075.0510</b> <b>M03330.075.0510</b>	Potenza assorbita apparecchio / Luminaire power consumption 36W Flusso luminoso apparecchio / Luminaire luminous flux 3059lm 2700K Ra>90 24V DC LED IP20	1,12
	<b>M03301.075.0410</b> <b>M03302.075.0410</b> <b>M03317.075.0410</b> <b>M03319.075.0410</b> <b>M03330.075.0410</b>	Potenza assorbita apparecchio / Luminaire power consumption 36W Flusso luminoso apparecchio / Luminaire luminous flux 3059lm 3000K Ra>90 24V DC LED IP20	1,12
	<b>M03301.100.0510</b> <b>M03302.100.0510</b> <b>M03317.100.0510</b> <b>M03319.100.0510</b> <b>M03330.100.0510</b>	Potenza assorbita apparecchio / Luminaire power consumption 47W Flusso luminoso apparecchio / Luminaire luminous flux 4079lm 2700K Ra>90 24V DC LED IP20	1,43
	<b>M03301.100.0410</b> <b>M03302.100.0410</b> <b>M03317.100.0410</b> <b>M03319.100.0410</b> <b>M03330.100.0410</b>	Potenza assorbita apparecchio / Luminaire power consumption 47W Flusso luminoso apparecchio / Luminaire luminous flux 4079lm 3000K Ra>90 24V DC LED IP20	1,43
	<b>M03301.100.0510</b> <b>M03302.100.0510</b> <b>M03317.100.0510</b> <b>M03319.100.0510</b> <b>M03330.100.0510</b>	Potenza assorbita apparecchio / Luminaire power consumption 47W Flusso luminoso apparecchio / Luminaire luminous flux 4079lm 2700K Ra>90 24V DC LED IP20	1,43
	<b>M03301.100.0410</b> <b>M03302.100.0410</b> <b>M03317.100.0410</b> <b>M03319.100.0410</b> <b>M03330.100.0410</b>	Potenza assorbita apparecchio / Luminaire power consumption 47W Flusso luminoso apparecchio / Luminaire luminous flux 4079lm 3000K Ra>90 24V DC LED IP20	1,43
	<b>A03301.025.0501</b> <b>A03302.025.0501</b> <b>A03317.025.0501</b> <b>A03319.025.0501</b> <b>A03330.025.0501</b>	Potenza assorbita apparecchio / Luminaire power consumption 13W Flusso luminoso apparecchio / Luminaire luminous flux 796lm 2700K Ra>90 220-240V AC ON-OFF LED IP40	0,62
	<b>A03301.025.0401</b> <b>A03302.025.0401</b> <b>A03317.025.0401</b> <b>A03319.025.0401</b> <b>A03330.025.0401</b>	Potenza assorbita apparecchio / Luminaire power consumption 13W Flusso luminoso apparecchio / Luminaire luminous flux 796lm 3000K Ra>90 220-240V AC ON-OFF LED IP40	0,62

Fotometrie disponibili [www.panzeri.it](http://www.panzeri.it) / Photometric data available at [www.panzeri.it](http://www.panzeri.it)

CODICI COLORI DISPONIBILI / COLOUR CODES AVAILABLE

**01** bianco  
white

**02** nero  
black

**17** bronzo  
bronze

**19** ottone satinato  
mat brass

**30** titanio  
titanium

**ROSONI PER ZERO SHAPES A PAGINA 152 / CANOPIES FOR ZERO SHAPES ON PAGE 152**

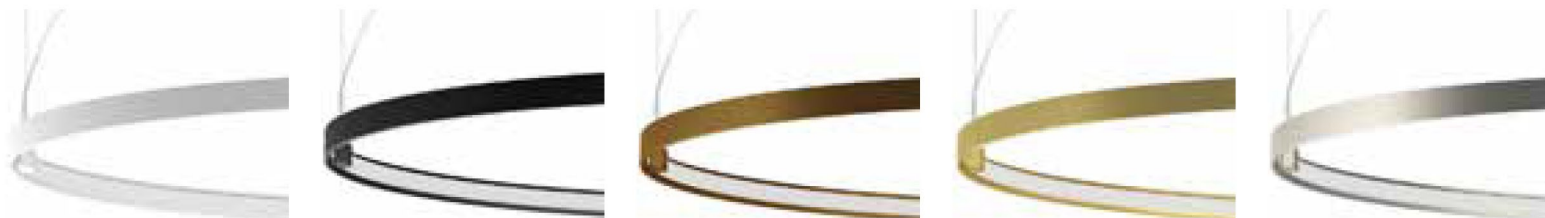



# ZERO SHAPES















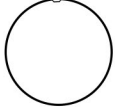



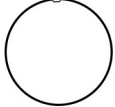



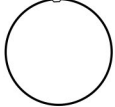

Enzo Panzeri 2018

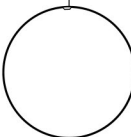

Lampada a sospensione verticale in alluminio estruso curvato con schermo in policarbonato opale. Emissione interna attraverso modulo LED e tecnologia DALI/Push DIM di serie su tutte le versioni inserita nel rosone.

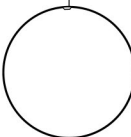
Anello rifinito con vernice poliaccrilica color bianco, nero, titanio, bronzo e ottone satinato. Possibili colori custom su richiesta. Disponibilità di rosone per installazioni singole e rosone per composizioni multiple da ordinare separatamente. Ideale per uffici, hall, zone living, grandi spazi, anche in abbinamento con **Zero Round Acoustic** e **Arena Acoustic**.

Vertical suspension lamp in extruded curved aluminum with opal polycarbonate screen. Emission of internal light through LED module and DALI/Push DIM technology on all the versions in the canopy. Polyacrylic white, black titanium bronze or mat brass painted. Canopy for single installations and canopies for multiple configurations are available, to be ordered separately. Ideal for offices, halls, living areas, large spaces, also combined with **Zero Round Acoustic** and **Arena Acoustic**.

	CODICE CODE	FONTI LUMINOSE LIGHT SOURCES	kg
 <p>500 197"</p> <p>Ø 50 Ø 19 3/8"</p>	 <b>M03401.050.0510</b>	Potenza assorbita apparecchio / Luminaire power consumption 25W	0,81
	<b>M03402.050.0510</b>	Flusso luminoso apparecchio / Luminaire luminous flux 2039lm	
	<b>M03417.050.0510</b>	2700K Ra>90 24V DC	
	<b>M03419.050.0510</b>	 <b>IP20</b> 	
	<b>M03430.050.0510</b>	Fornito senza rosone e driver, per composizioni singole o multiple Supplied without canopy and driver, for multiple configurations	
 <p>500 197"</p> <p>Ø 74 Ø 29 1/8"</p>	 <b>M03401.050.0410</b>	Potenza assorbita apparecchio / Luminaire power consumption 25W	0,81
	<b>M03402.050.0410</b>	Flusso luminoso apparecchio / Luminaire luminous flux 2039lm	
	<b>M03417.050.0410</b>	3000K Ra>90 24V DC	
	<b>M03419.050.0410</b>	 <b>IP20</b> 	
	<b>M03430.050.0410</b>	Fornito senza rosone e driver, per composizioni singole o multiple Supplied without canopy and driver, for multiple configurations	
 <p>500 197"</p> <p>Ø 74 Ø 29 1/8"</p>	 <b>M03401.075.0510</b>	Potenza assorbita apparecchio / Luminaire power consumption 36W	1,09
	<b>M03402.075.0510</b>	Flusso luminoso apparecchio / Luminaire luminous flux 3059lm	
	<b>M03417.075.0510</b>	2700K Ra>90 24V DC	
	<b>M03419.075.0510</b>	 <b>IP20</b> 	
	<b>M03430.075.0510</b>	Fornito senza rosone e driver, per composizioni singole o multiple Supplied without canopy and driver, for multiple configurations	
 <p>500 197"</p> <p>Ø 74 Ø 29 1/8"</p>	 <b>M03401.075.0410</b>	Potenza assorbita apparecchio / Luminaire power consumption 36W	1,09
	<b>M03402.075.0410</b>	Flusso luminoso apparecchio / Luminaire luminous flux 3059lm	
	<b>M03417.075.0410</b>	3000K Ra>90 24V DC	
	<b>M03419.075.0410</b>	 <b>IP20</b> 	
	<b>M03430.075.0410</b>	Fornito senza rosone e driver, per composizioni singole o multiple Supplied without canopy and driver, for multiple configurations	
 <p>500 197"</p> <p>Ø 98 Ø 38 5/8"</p>	 <b>M03401.100.0510</b>	Potenza assorbita apparecchio / Luminaire power consumption 47W	1,39
	<b>M03402.100.0510</b>	Flusso luminoso apparecchio / Luminaire luminous flux 4079lm	
	<b>M03417.100.0510</b>	2700K Ra>90 24V DC	
	<b>M03419.100.0510</b>	 <b>IP20</b> 	
	<b>M03430.100.0510</b>	Fornito senza rosone e driver, per composizioni singole o multiple Supplied without canopy and driver, for multiple configurations	
 <p>500 197"</p> <p>Ø 98 Ø 38 5/8"</p>	 <b>M03401.100.0410</b>	Potenza assorbita apparecchio / Luminaire power consumption 47W	1,39
	<b>M03402.100.0410</b>	Flusso luminoso apparecchio / Luminaire luminous flux 4079lm	
	<b>M03417.100.0410</b>	3000K Ra>90 24V DC	
	<b>M03419.100.0410</b>	 <b>IP20</b> 	
	<b>M03430.100.0410</b>	Fornito senza rosone e driver, per composizioni singole o multiple Supplied without canopy and driver, for multiple configurations	

Fotometrie disponibili [www.panzeri.it](http://www.panzeri.it) / Photometric data available at [www.panzeri.it](http://www.panzeri.it)

## CODICI COLORI DISPONIBILI / COLOUR CODES AVAILABLE

- 01** bianco  
white
- 02** nero  
black
- 17** bronzo  
bronze
- 19** ottone satinato  
mat brass
- 30** titanio  
titanium

**ROSONI PER ZERO SHAPES A PAGINA 152 / CANOPIES FOR ZERO SHAPES ON PAGE 152**







# ZERO SHAPES

Enzo Panzeri 2019



Lampada a sospensione in alluminio estruso curvato con schermo in policarbonato opale. Emissione interna attraverso modulo LED e tecnologia DALI/Push DIM di serie su tutte le versioni inserita nel rosone. Anello rifinito con vernice poliaccrilica color bianco, nero, titanio, bronzo e ottone satinato. Possibili colori custom su richiesta. Disponibilità di rosone per installazioni singole e composizioni multiple in abbinamento a Zero Round e Zero Square da ordinare separatamente. Ideale per uffici, hall, zone living, grandi spazi, anche con **Zero Round Acoustic** e **Arena Acoustic**.

Suspension lamp in extruded curved aluminium with opal polycarbonate screen. Emission on the internal side provided by LED modules with technology DALI/ Push DIM integrated into the canopy. Polyacrilic paint white, black, titanium, bronze and mat brass finishes are available. Custom colors are available on request. Canopies for single and multiple configurations with Zero Round and Zero Square are available, to be ordered separately. Ideal for offices, halls, living, and public spaces, also combined with **Zero Round Acoustic** and **Arena Acoustic**.

	CODICE CODE	FONTI LUMINOSE LIGHT SOURCES	kg
	<b>M03101.130.0510</b> <b>M03102.130.0510</b> <b>M03117.130.0510</b> <b>M03119.130.0510</b> <b>M03130.130.0510</b>	Potenza assorbita apparecchio / Luminaire power consumption 47W Flusso luminoso apparecchio / Luminaire luminous flux 4079lm 2700K Ra>90 24V DC <b>IP20</b>	1,53
	<b>M03101.130.0410</b> <b>M03102.130.0410</b> <b>M03117.130.0410</b> <b>M03119.130.0410</b> <b>M03130.130.0410</b>	Potenza assorbita apparecchio / Luminaire power consumption 47W Flusso luminoso apparecchio / Luminaire luminous flux 4079lm 3000K Ra>90 24V DC <b>IP20</b>	1,53
	Fornito senza rosone e driver, per composizioni singole o multiple Supplied without canopy and driver, for multiple configurations		
	Fornito senza rosone e driver, per composizioni singole o multiple Supplied without canopy and driver, for multiple configurations		
	Fornito senza rosone e driver, per composizioni singole o multiple Supplied without canopy and driver, for multiple configurations		

Fotometrie disponibili [www.panzeri.it](http://www.panzeri.it) / Photometric data available at [www.panzeri.it](http://www.panzeri.it)

### CODICI COLORI DISPONIBILI / COLOUR CODES AVAILABLE

- 01** bianco  
white
- 02** nero  
black
- 17** bronzo  
bronze
- 19** ottone satinato  
mat brass
- 30** titanio  
titanium

### ROSONI PER ZERO SHAPES A PAGINA 152 / CANOPIES FOR ZERO SHAPES ON PAGE 152







# ZERO SHAPES

Enzo Panzeri 2019



Lampada a sospensione in alluminio estruso curvato con schermo in policarbonato opale. Emissione interna attraverso modulo LED e tecnologia DALI/Push DIM di serie su tutte le versioni inserita nel rosone. Anello rifinito con vernice poliaccrilica color bianco, nero, titanio, bronzo e ottone satinato. Possibili colori custom su richiesta. Disponibilità di rosone per installazioni singole e composizioni multiple in abbinamento a Zero Ellipse e Zero Round da ordinare separatamente. Ideale per uffici, hall, zone living, grandi spazi, anche in abbinamento con **Zero Round Acoustic** e **Arena Acoustic**.

Suspension lamp in extruded curved aluminium with opal polycarbonate screen. Emission on the internal side provided by LED modules with technology DALI/ Push DIM integrated into the canopy. Polyacrilic paint white, black, titanium, bronze and mat brass finishes are available. Custom colors are available on request. Canopies for single and multiple configurations with Zero Ellipse and Zero Round are available, to be ordered separately. Ideal for offices, halls, living, and public spaces, also combined with **Zero Round Acoustic** and **Arena Acoustic**.

	CODICE CODE	FONTI LUMINOSE LIGHT SOURCES	kg
	<b>M03201.050.0510</b> <b>M03202.050.0510</b> <b>M03217.050.0510</b> <b>M03219.050.0510</b> <b>M03230.050.0510</b>	Potenza assorbita apparecchio / Luminaire power consumption 25W Flusso luminoso apparecchio / Luminaire luminous flux 2039lm 2700K Ra>90 24V DC <b>LED IP20</b>	0,92
	<b>M03201.050.0410</b> <b>M03202.050.0410</b> <b>M03217.050.0410</b> <b>M03219.050.0410</b> <b>M03230.050.0410</b>	Potenza assorbita apparecchio / Luminaire power consumption 25W Flusso luminoso apparecchio / Luminaire luminous flux 2039lm 3000K Ra>90 24V DC <b>LED IP20</b>	0,92
	Fornito senza rosone e driver, per composizioni singole o multiple Supplied without canopy and driver, for multiple configurations		
	Fornito senza rosone e driver, per composizioni singole o multiple Supplied without canopy and driver, for multiple configurations		
	Fornito senza rosone e driver, per composizioni singole o multiple Supplied without canopy and driver, for multiple configurations		
	<b>M03201.075.0510</b> <b>M03202.075.0510</b> <b>M03217.075.0510</b> <b>M03219.075.0510</b> <b>M03230.075.0510</b>	Potenza assorbita apparecchio / Luminaire power consumption 36W Flusso luminoso apparecchio / Luminaire luminous flux 3059lm 2700K Ra>90 24V DC <b>LED IP20</b>	1,21
	<b>M03201.075.0410</b> <b>M03202.075.0410</b> <b>M03217.075.0410</b> <b>M03219.075.0410</b> <b>M03230.075.0410</b>	Potenza assorbita apparecchio / Luminaire power consumption 36W Flusso luminoso apparecchio / Luminaire luminous flux 3059lm 3000K Ra>90 24V DC <b>LED IP20</b>	1,21
	Fornito senza rosone e driver, per composizioni singole o multiple Supplied without canopy and driver, for multiple configurations		
	Fornito senza rosone e driver, per composizioni singole o multiple Supplied without canopy and driver, for multiple configurations		
	Fornito senza rosone e driver, per composizioni singole o multiple Supplied without canopy and driver, for multiple configurations		

Fotometrie disponibili [www.panzeri.it](http://www.panzeri.it) / Photometric data available at [www.panzeri.it](http://www.panzeri.it)

### CODICI COLORI DISPONIBILI / COLOUR CODES AVAILABLE

- 01** bianco  
white
- 02** nero  
black
- 17** bronzo  
bronze
- 19** ottone satinato  
mat brass
- 30** titanio  
titanium

### ROSONI PER ZERO SHAPES A PAGINA 152 / CANOPIES FOR ZERO SHAPES ON PAGE 152

